

Centrifan™ PE Personal Evaporator

User Manual



Modular SFC, Inc.

842 Upper Union Street #3

Franklin, MA 02038

Phone: (508) 520-4000

infor@modularsfc.com

Fax: (508) 520-4094

www.modularsfc.com

Part Number 21087

Version 9.20

Notices:

This system is covered by a limited lifetime warranty. A copy of the warranty is included with this manual. The operator is not required to perform routine maintenance, but procedures for disassembly and cleaning are as described herein. For cleaning procedures, refer to Chapter 4.

All information in this manual is subject to change without notice and does not represent a commitment on the part of Modular SFC, Inc.

The system and various components in the system are the subject of various pending patents.

©2010-2011 Modular SFC, Inc. All rights reserved. No part of this manual may be reproduced or transmitted in any form or by any means without the written permission of Modular SFC, LLC. All trademarks of other companies are acknowledged to the property of the respective owners.

Modular SFC and Centrifan are trademarks of Modular SFC, Inc.

Printed in the United States of America.

Warnings and Safety Precautions

The following precautions should be followed to minimize the possibility of personal injury and/or damage to property while using the Centrifan PE.

1. **Maintain a Well-Ventilated Laboratory**

Volatile organic solvents may be used in the system. Ensure that the laboratory is well ventilated so that a buildup of vaporized solvent cannot occur.

2. **Ensure That Solvent Vapor Is Not Allowed To Escape Into The Laboratory**

Any organic solvent vapor must be vented to an external venting system so that it cannot collect in the laboratory.

3. **Avoid Open Flames And Sparks**

Volatile organic solvents may be used in the system. Do not use an open flame in the laboratory and do not install any equipment that can cause sparks or other ignition sources in proximity to the instrument.

4. **The System Must be Plugged Into A Grounded Power Receptacle**

Ensure that all parts of the system are properly grounded. Do **not** attempt to bypass the earth ground connection. A serious shock hazard could result.

5. **Treat All Samples And Solvents As If They May Contain Hazardous Substances Or Transmit Disease**

The samples and/or solvents that are handled by the system may contain compounds that could present a hazard to the operator of the instrument. Take all precautions to ensure that they do not come into contact with the skin or eyes. A sink and eyewash should be located in the laboratory. In the event of an accident, wash the affected part with copious quantities of water and seek medical assistance. If you are handling biological/clinical samples, treat them in accordance with the infectious disease control program of your institution.

6. **Do Not Disassemble Any Part Of The Instrument Which Requires A Tool**

There are no user serviceable parts inside the base of the instrument enclosure or under the heater assembly in the lid. It is not necessary to remove any enclosure screws to perform the cleaning procedures envisaged for the user of the instrument.

7. **Wear Protective Eyewear**

Reagents used in the system can damage your eyes. Protective eyewear should be worn by the operator. The system should be used in proximity to an eyewash sink. If any solvents or chemicals splash on the skin or eyes, immediately rinse the affected parts in the sink. Obtain medical help as needed.

8. Use the System In A Proper Manner

Do not use the instrument and/or its accessories in a manner not specified by Modular SFC. If you do so, the protection provided by safety interlocks may be impaired.

9. Do Not Attempt To Bypass Any Safety Interlocks

The safety interlocks are provided to comply with safety requirements of various regulatory agencies and must be employed to protect the operator. The lid should be fully down and the latch engaged when the instrument is in use. Do not use your hands or any implement to slow the rotor at the completion of an evaporation process. Allow the rotor to come to rest without interference. The motor is equipped with a braking function which is engaged when the latch is disengaged and will stop the rotor in just a few seconds.

10. Wear Gloves When Handling Dry Ice

Dry ice can cause serious burns to the skin. Casually dropping dry ice nuggets into the trap can splash the ethanol liquid out of the internal cold finger. Use care when adding dry ice to not cause a spill.

11. Ensure That Circulation Exists Between The Cold Trap Ports

The function of the Centrifan PE is to accelerate evaporation of sample solvent. The solvent must be condensed out of the recirculating gas volume within the instrument or continued evaporation will not occur. The outlet port at the back left of the instrument and the inlet port at the back right should be connected in series with a dry ice trap or a mechanical cold trap to obtain maximum green solvent recovery benefit.

Warranty

Modular SFC, Inc (Modular SFC) warrants that its products will be free from defects in materials and workmanship under normal use and service in general process conditions for a period of three years from the date of purchase. This warranty and its remedies apply only to the original purchaser of the instrument and are in lieu of all other warranties expressed or implied, oral or written, either in fact or by operation of law, statutory or otherwise, including warranties of merchantability and fitness for a particular purpose, which Modular SFC specifically disclaims. Modular SFC shall have no liability for incidental or consequential damages of any kind arising out of the sale, installation, or use of its products.

Modular SFC's obligation under this warranty shall not arise until Buyer notifies Modular SFC of the defect. Modular's SFC's sole responsibility under this warranty is to replace any defective component part of the product. This service obligation does not extend to cold trap glassware or the plastic rotor components which are relatively fragile and potentially subject to much handling in normal use of the instrument. Except in the case of an authorized distributor or seller, authorized in writing by Modular SFC to extend this warranty to the distributor's customers, the warranty herein applies only to Buyer as the original purchaser from Modular SFC and may not be assigned, sold, or otherwise transferred to a third party.

No warranty is made with respect to used, reconstructed, refurbished, or previously owned Products, which will be so marked on the sales order and will be sold "As Is".

BUYER'S SOLE AND EXCLUSIVE REMEDY UNDER THIS WARRANTY IS THAT MODULAR SFC AGREES TO REPLACE ANY PART OR PARTS OF SUCH PRODUCTS THAT UNDER PROPER AND NORMAL CONDITIONS OF USE, PROVE(S) TO BE DEFECTIVE. ALTERNATELY, MODULAR SFC MAY AT ANY TIME, IN ITS SOLE DISCRETION, ELECT TO DISCHARGE ITS WARRANTY OBLIGATION HEREUNDER BY ACCEPTING THE RETURN OF ANY DEFECTIVE PRODUCT PURSUANT TO THE TERMS SET FORTH HEREIN AND REFUNDING THE PURCHASE PRICE PAID BY BUYER.

Effective Date

The effective date of this warranty shall begin on the date of shipment/date of invoice, whichever is later.

Limitations

Products are warranted to be free from defects in materials and workmanship for parts and labor to the original purchaser with the exceptions indicated below:

- Any components of the system that are in direct contact with liquids are warranted to be free from defects in materials and workmanship at time of delivery but cannot be further warranted due to the unknown nature of the use of the product. Materials of construction should be compatible with the compounds and solvents being processed.
- Consumable items such as Tubing, Fittings, Test Tubes and Glassware are excluded from this warranty. The rotor insert which holds the solvent containers and the rotor cover cannot be warranted due to their fragile nature.
- Loss, damage, or defects resulting from transportation to the Buyer's facility, improper use, software or interfaces supplied by the buyer, unauthorized modification or operation outside the environmental specifications for the instrument, use by unauthorized or untrained personnel or improper site maintenance or preparation.
- The sole and exclusive warranty applicable to software and firmware products provided by Modular SFC for use with a processor internal or external to the Product will be as follows: Modular SFC warrants that such software and firmware will conform to Modular SFC's program manuals or other publicly available documentation made available by Modular SFC's current at the time of shipment to Buyer when properly installed on that processor, provided however that Modular SFC does not warrant the operation of the processor or software or firmware will be uninterrupted or error-free.
- Products that have been altered or repaired by individuals other than Modular SFC personnel or its duly authorized representatives, unless the alteration or repair has been performed by an authorized factory trained service technician in accordance with written procedures supplied by Modular SFC.
- Products that have been subject to misuse, neglect, accident, or improper installation.

The warranty herein applies only to Products within the country of original delivery. Products transferred outside the country of original delivery, either by Modular SFC at the direction of the Buyer or by Buyer's actions subsequent to delivery, may be subject to additional charges prior to warranty repair or replacement of such Products based on the actual location of such Products and Modular SFC's warranty and/or service surcharges for such location(s).

The warranty period for data processing equipment, including data storage devices, processors, printers, terminals, communication interfaces, tape drives, and/or all similar devices, is in all cases limited to ninety (90) days from the date of shipment to Buyer.

Replaced products assume the ongoing warranty of the originally purchased instrument with the above exceptions.

Safety/Operating Symbols

The following symbols appearing in the manual are defined as follows:



The WARNING statement used throughout the manual presents dangers that could result in personal injury.



The CAUTION statement used throughout the manual presents hazards on conditions that could cause damage to the instrument or the reporting of erroneous results.



The NOTE statement used throughout the manual highlights important information about the instrument and its use.

Failure to follow these statements may invalidate the warranty.

Table of Contents

Warnings and Safety Precautions	iii
Warranty	v
Safety/Operating Symbols	vii
Table of Contents	ix
Chapter 1 Introduction	1-1
1.1 Overview	1-1
1.2 Mode of Operation.....	1-2
1.3 Benefits of the Centrifan PE.....	1-4
1.4 System Configuration and Accessories.....	1-4
1.5 Contents of this Manual	1-4
1.6 For Further Information.....	1-5
Chapter 2 Installation	2-1
2.1 Overview	2-1
2.2 Location of the System	2-1
2.3 Space Requirements	2-1
2.4 Electrical Requirements.....	2-2
2.5 Unpacking the System.....	2-2
2.6 Assembling the System	2-3
2.7 Connections for Evaporation with Inert Gas	2-6
Chapter 3 Operation	3-1
3.1 Preparing the Centrifan for Operation	3-1
3.2 Set-Up the Cold Trap.....	3-2
3.2.1 Low-Boiling Solvents.....	3-2
3.2.2 Frozen Water Bottle Convenience with Higher-Boiling Solvents.....	3-3
3.3 Loading Samples in the Centrifan PE.....	3-4
3.4 Setting the Temperature	3-6
3.5 Setting the Timer	3-6
3.5.1 Operating in Manual Mode	3-6
3.5.2 Operating in Timer Mode	3-6
3.5.3 Switching between Manual and Timer Modes.....	3-7
Chapter 4 Maintenance and Troubleshooting	4-1
4.1 Maintenance.....	4-1
4.1.1 Cleaning the System.....	4-1
4.1.2 Removing the Stainless Liner for Cleaning.....	4-1
4.1.3 Routine Inspection.....	4-2
4.2 Troubleshooting.....	4-2
Appendix A Specifications	A-1
Appendix B Spare Parts and Accessories.....	B-1
Appendix C Index	C-1

Chapter 1 Introduction

1.1 Overview

The Centrifan PE - Personal Evaporator (Figure 1-1) employs an innovative recirculating evaporation technology to evaporate both aqueous and organic solvents to allow for the isolation of non-volatile solutes from liquid samples. It replaces conventional “blow-down” systems and ensures safe, rapid evaporation of solvent while ensuring sample yield and purity and optimizing solvent recovery.



Figure 1-1: The Centrifan PE - Personal Evaporator

1.2 Mode of Operation

The operation of the Centrifan PE involves spinning of the liquid samples via a rotor and directing a gas flow from a fan over the solvent surface to accelerate evaporation. The vaporized solvent is swept from the sample area and directed to the cold trap where the vapors are condensed. The solvent free gas is then returned to the Centrifan PE enclosure to pick up more solvent vapor. The two circulation paths are traced in a basic functional diagram of the instrument depicted in Figure 1-2.

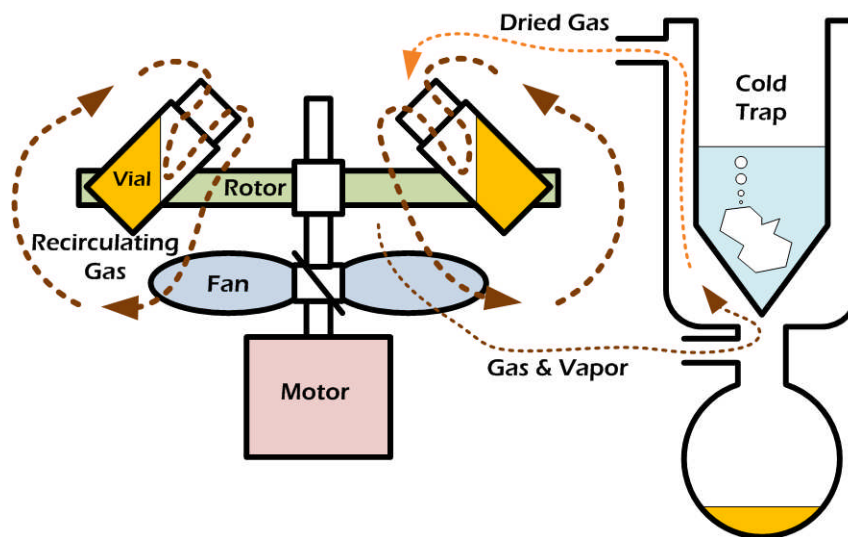

Figure 1-2: Evaporation and Condensation Gas Flows

The actual circulation paths are traced through a cross section of the instrument depicted in Figure 1-3.

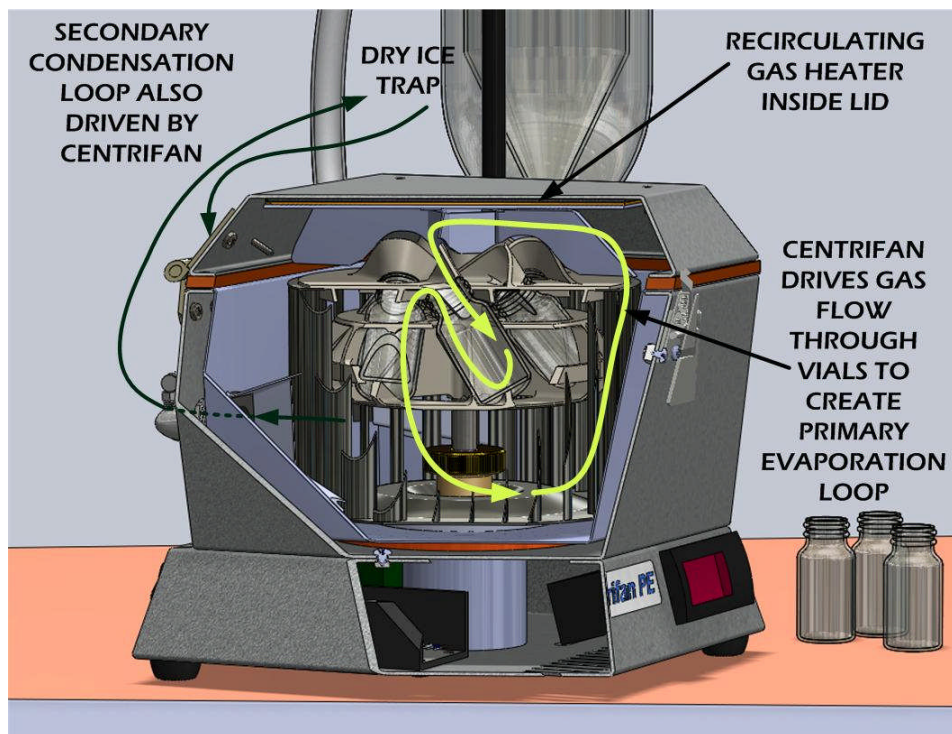

Figure 1-3: Evaporation Path in Green; Condensation Path in Black

There are two gas flows in the system:

- A *primary or evaporation* high flow path of recirculating gas removes solvent molecules from the liquid surface of the samples, which are contained in a rotor (right, yellow pathway of Figure 1-3).
- A *secondary or condensation* low flow loop continuously transfers gas with the solvent vapor to a cold trap for condensation and collection. After the solvent is removed, the gas is returned to the evaporation chamber (left, green pathway of Figure 1-3).

A heater in the lid maintains the desired gas temperature (the evaporation of solvent will cool the sample to below ambient unless thermal energy is added). If desired, the user can bleed in an inert gas such as Ar or N₂ to displace the air in the captured gas volume and protect samples from oxygen degradation.

1.3 Benefits of the Centrifan PE

The Centrifan PE system provides a number of benefits compared to commonly employed methods of solvent operation, including:

- The centrifugal force obtained by rotation of the samples forces the solute to the bottom of the collection vessel. In contrast, when a stream of gas is passed over the sample, it is possible that solute will be distributed into the atmosphere. When the Centrifan PE is employed, the dried sample remains in the bottom of the vial.
- If a blow-down apparatus is used, a significant amount of compressed air or an inert gas is required. The Centrifan PE generates its own gas flow via the internal centrifugal fan.
- If a blow-down apparatus is used, solvent vapor will be sent into the atmosphere. If an organic solvent is employed, this may lead to environmental and/or regulatory issues, even if the solvent is passed into a fume hood. The Centrifan PE condenses the solvent vapor in a cold trap and allows for safe disposal or recycling.
- A vacuum pump is not required, reducing both procurement and operating costs and eliminating a major source of downtime in vacuum concentration systems.
- Prefreezing of samples, required by lyophilization, is not required when using the Centrifan PE.
- The very small portable size of the Centrifan PE makes it suitable for flexible use in virtually any one-square-foot space.

1.4 System Configuration and Accessories

The system can be configured with a variety of rotors to accommodate:

21050	6 x 20 mL Scintillation Vials
21320	6 x 30 mL Scintillation Vials
21299	4 x 40 mL Scintillation Vials
21330	8 x 1.6 mL Eppendorf Tubes
21240	8 x 4 mL (1 dram) Vials
21180	6 x 16mm x 100mm Test Tubes

There is also an optional cold trap cover available, although in our experience, Parafilm over the top of the trap with a small perforation may be just as effective at slowing the evaporation rate of the alcohol or acetone being used in the trap.

21116	Cover, Cold Trap
-------	------------------

These optional items may be purchased by contacting the company directly or through any of our dealers.

1.5 Contents of this Manual

This Operator's Manual contains:

- **Installation** (*Chapter 2*) - describes the facilities required for the system and how to make the inert gas purge connections, if required.
- **Operation** (*Chapter 3*) - describes how to install and secure sample vials prior to running.

- **Maintenance and Troubleshooting** (*Chapter 4*) - describes how to remove the stainless liner for cleaning.
- **Specifications** (*Appendix A*) - describes general system specifications.
- **Spare Parts** (*Appendix B*) - lists consumable items and replacement parts for the system.

1.6 For Further Information

For further information, please contact:

Modular SFC, Inc.
842 Upper Union Street
Suite #3
Franklin, MA 02038
Phone: (508) 520-4000
Fax: (508) 520-4094
email: infor@modularsfc.com
www.modularsfc.com

or your local Modular SFC dealer.

Chapter 2 Installation

2.1 Overview



Note: The Centrifan PE Personal Evaporator is designed to be installed by the user.

This chapter describes general information about the location and the physical requirements of the system.

2.2 Location of the System

The Centrifan PE Personal Evaporator should be installed in a facility with the following environmental conditions:

- The temperature range of the laboratory should be between 15°C and 25°C (59°F - 77°F). The system should be installed in an area in which the temperature range is fairly constant (the suggested temperature variation is +/- 2°C/hr (+/- 5°F/hr)).
- The system should not be placed near a window, air conditioning duct, etc. or any device in which significant temperature changes may occur (e.g. an oven). The relative humidity of the area should meet the ASHRE standard for human comfort.
- If flammable solvents are to be used at any stage of the operation of the system, suitable ventilation should be provided and open flames must be prohibited in the laboratory.
- Corrosive vapors, solvents and dust should not be allowed in the laboratory as these can affect system performance.

The general guidelines provided above apply to typical installations. In certain special applications such as drying proteins and peptides, it may be desirable to place the unit in a refrigerator to maintain near-0°C conditions to minimize degradation.

The unit has been tested at the aqueous freezing point and the heater has sufficient power to raise the temperature about 35°C above ambient. In other words, to achieve a peptide evaporation environment of 9°C the Centrifan PE could be placed in a 4°C refrigerator and the temperature controller set for 9°C.

2.3 Space Requirements

The dimensions of the Centrifan PE Personal Evaporator are 12" (30.5 cm) W x 18" (45.7 cm) H x 8" (20.3 cm) D. Some clearance to the front of the unit should be provided to set the temperature control and to operate the lid latch for the loading and unloading of sample vials.

2.4 Electrical Requirements

The Centrifan PE Personal Evaporator is provided in two versions for either 115VAC or 230VAC. Both versions operate with 50-60Hz and 200 watts. A label on the rear panel indicates the version and the user should ensure that the power requirements match the power provided by the mains.

The AC voltage connection to the system must include an earth ground for operator safety. The system should not be connected to a power line that is susceptible to significant changes in power requirements such as a power line that is connected to a compressor, oven or other source of heat generation. If it is possible that significant changes in the power may occur, a constant voltage transformer may be required.

The system should not be installed near equipment that generates strong electromagnetic fields. If the power line is noisy, it may be necessary to install a noise filter.

These general electrical guidelines are far more applicable to a microprocessor-based instrument with analog data processing capability; the Centrifan PE, with only a temperature controller module (performing any analog control functions) should be immune to all but the most severe power conditions.

2.5 Unpacking the System

The Centrifan PE Personal Evaporator and its accessories are shipped in the same container. Unpack components carefully, making sure all items in the list below have been included and are in good condition. Save the container and packing material for convenient and secure relocation of the instrument.

The Centrifan PE Personal Evaporator is shipped with the following items:

- Centrifan PE unit
- Rotor installed in unit including
 - Centrifugal Fan
 - Rotor
 - Polypropylene Splitter Disk
- Cold trap glassware
- 500mL round collection flask
- Cold trap holder
- Clamp for ball joint
- Line cord
- Manual

The Centrifan PE Personal Evaporator has been carefully packed and shipped to ensure that it is received in proper condition. Any damage to the container or its contents should be reported immediately to your local distributor or to Modular SFC, Inc. Please refer to the warranty (page v), Warranty, Returns, and Repairs, for more information.

If replacement parts are needed, please refer to Appendix B, Replacement Parts for part numbers.

2.6 Assembling the System

The interior of the Centrifan PE Personal Evaporator is shown in Figure 2-1.

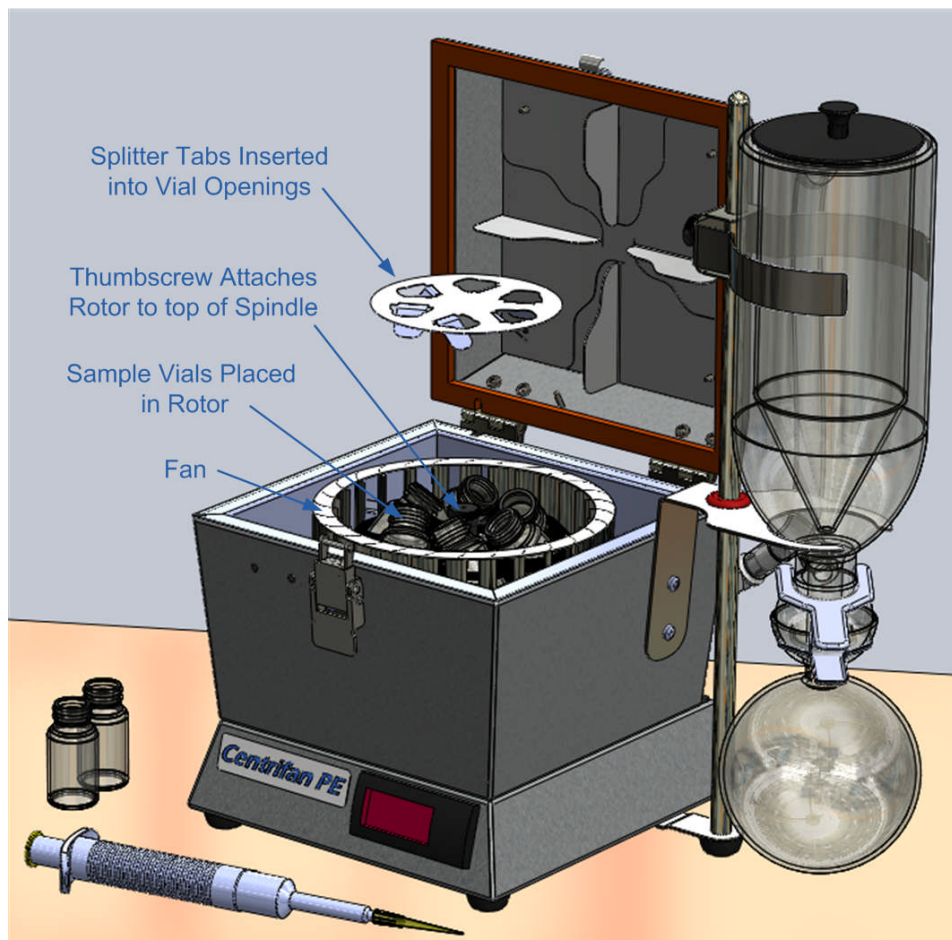

Figure 2-1: Internal Components

To install the system:

- a) Remove the Centrifan PE unit from its carton, set it on a suitable work surface, and open the lid by lifting the spring-loaded latch. Remove any packing material present and confirm that the centrifugal fan turns freely.

- b) Gently withdraw each tab attached to the polypropylene splitter disk from the sample vials. Verify that the knurled retaining nut at the center of the rotor is snugly tightened to retain the rotor within the fan. Remove the vials from the rotor and the rotor is now ready to accept your samples.
- c) Give the rotor assembly a good spin, tentatively close the lid again and lock the latch. There should be no visual or audible indication that there is any contact between the rotor and any internal parts of the enclosure.
- d) Locate the large glassware clamp and slide it down on the top of the bar a few inches and loosely tighten the retaining screw.
- e) Feed the cold trap down through the retaining ring and rest the curved bottom cold trap glassware in the U-shaped cradle of the bracket as shown in Figure 2-3. Rotate the cold trap into its final position so that the tubing connection fittings are directed to the rear of the Centrifan PE unit.

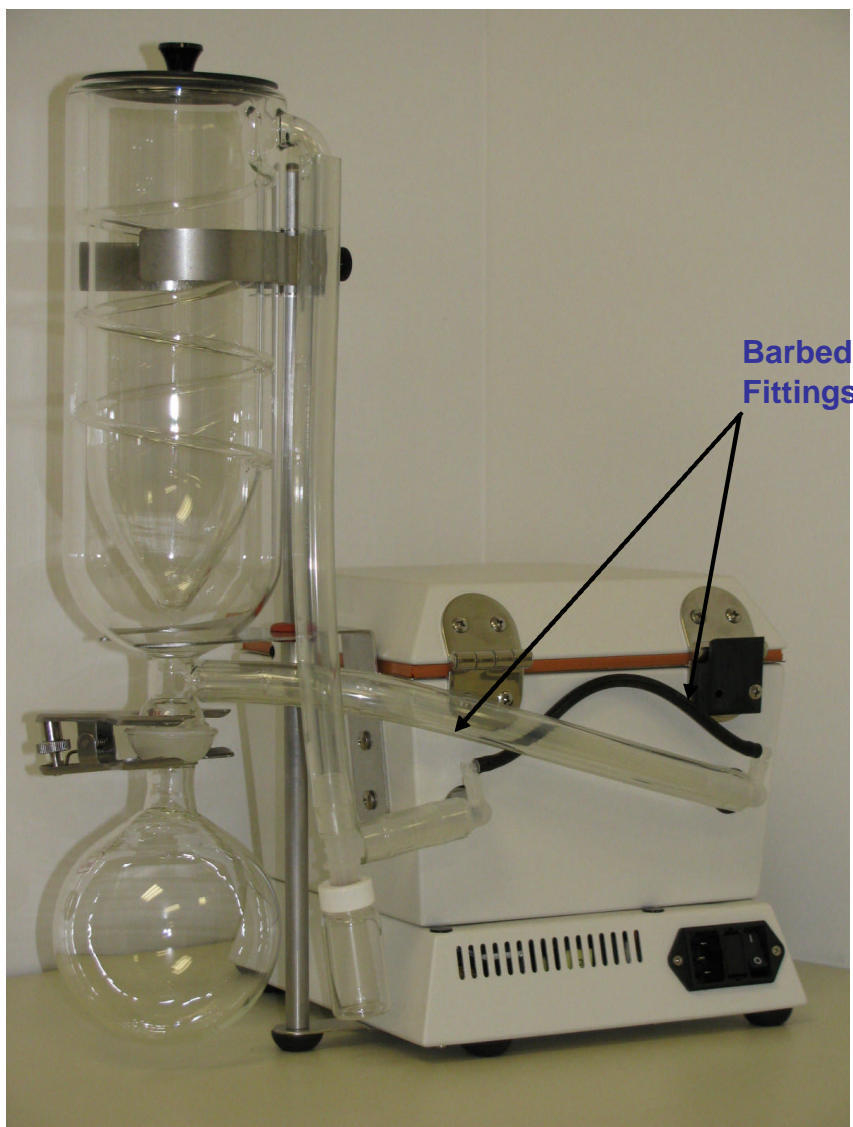

Figure 2-3: Attaching the Cold Trap Assembly and Associated Tubing

- f) Locate the three pieces of ½" ID tubing and make the connections on the back of the Centrifan PE unit as shown in Figure 2-3. Twist the plastic fittings as required to

make the connections from the cold trap. The ½" T-fitting is used to attach a 20mL scintillation vial at the bottom of the cold trap return tubing. This vial helps prevent any condensate which forms in the cold trap exit tube from re-entering the enclosure and slowing the evaporation process.

- g) If your application will not require drying in an oxygen-free environment, leave the jumper-piece of 1/8" ID tubing between the two small barbed fittings as shown in Figure 2-3.



Note: If you require evaporation with an oxygen-free environment, see the instructions for adding the tubing designed to purge the enclosure with inert gas in Section 2.7.

2.7 Connections for Evaporation with Inert Gas

If you desire to purge the drying enclosure of air by bleeding dry nitrogen or another gas into the process as it runs, then procure a length of 1/8" ID tubing. It should be long enough to connect from an inert gas of choice to the back of the Centrifan PE unit and also for providing a vent connection to any convenient exhaust system such as a fume hood or elephant trunk

- Locate the Centrifan PE a convenient distance from both the supply of inert gas and the hood or exhaust trunk which will be used to vent the system.
- The 1/8 barb fitting screwed into the larger 1/2" fitting closest to the cold trap should be connected to a nitrogen, argon, or other inert gas supply at a very low pressure.
- The 1/8 barb fitting located on the fitting above the power connector should be connected to a length of 1/8" ID tubing which will serve as the means of venting an equal gas volume to that being introduced through the other fitting. This arrangement maintains approximate atmospheric pressure within the enclosure at all times.
- To visualize and help set the low volume of gas introduced to the system, it may be helpful to dip the end of the vent tube in a beaker of water and regulate the minimal inert gas bleed by monitoring the trickle of bubbles within the beaker.

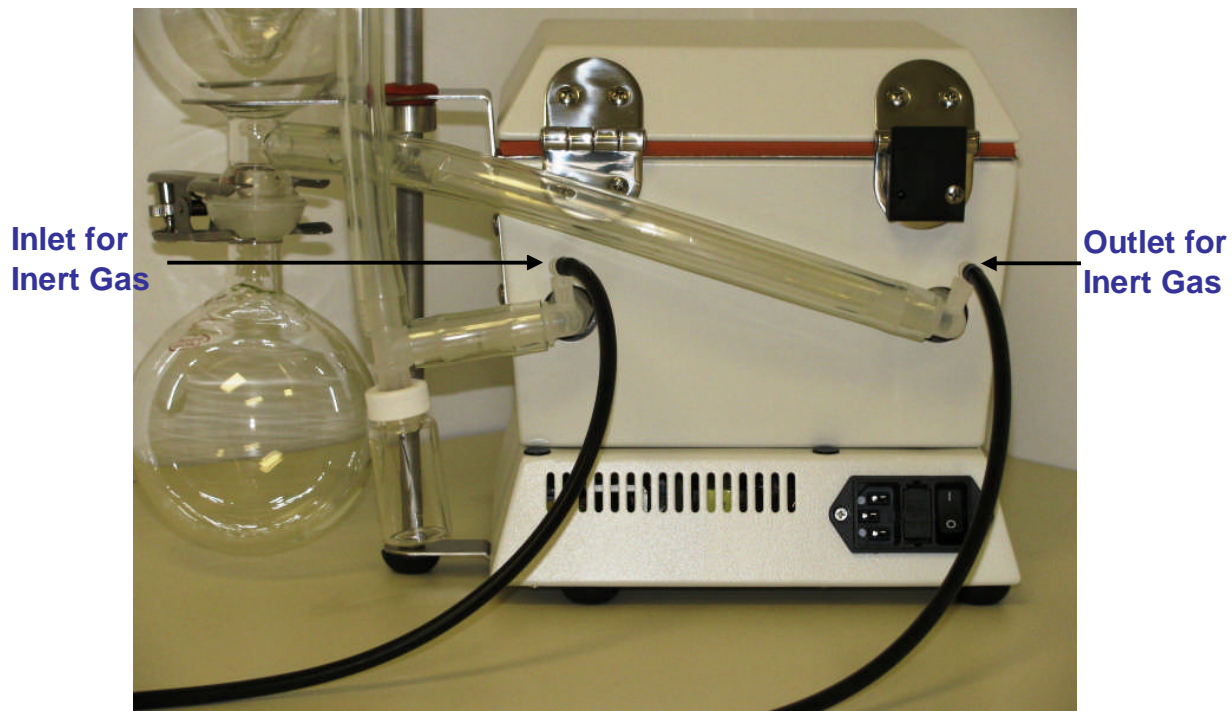

Figure 2-4: Inlet (left) and Vent (right) Connections for Inert Gas Evaporation

Chapter 3 Operation

3.1 Preparing the Centrifan for Operation

To prepare the system for initial operation:



Note: The Centrifan PE and the attached cold trap should be placed in a convenient location for loading and removing sample vials and for the occasional addition of dry ice to the cold trap.

- a) Insure that all hoses are routed correctly and securely pressed onto their fittings.
- b) Unlatch the lid and open the instrument for rotor access. Remove the splitter disk and any vials. Make sure the thumbscrew in the center of the rotor is reasonably, but not overly, tight.
- c) Turn the centrifugal fan containing the rotor and look inside the Centrifan PE enclosure to make sure there is no foreign material in the unit which could cause damage to the equipment or your samples. The fan should turn freely and make no sound. Spin the rotor again and latch the lid to insure there is no contact between the rotor components and the heatsink on the underside of the lid.



Note: Ensure that the system is configured for the voltage supplied by the mains. The voltage configuration is indicated on the rear of the unit.

- d) Check that the power switch at the back of the system is set to off and plug the unit into an appropriate AC power source. The line cord receptacle is located at the rear of the unit.
- e) Open the lid again, reach behind the unit just to the outside of the power cord and turn on the main power switch. The temperature controller display will illuminate red indicating that the power is on.
- f) Latch the lid again which will cause the rotor begin spinning. Allow the rotor about 5 seconds to achieve full speed and be aware of any unusual noise or vibration. The instrument is extremely quiet and smooth running. One way to know that it is running properly is to listen for the distinctive rushing sound of the trapped gas volume circulating within the enclosure.
- g) When it is clear that the unit is running properly, lift the lid. The motor brake will stop the rotor in a few seconds. The unit is now ready to install the sample containers, the splitter disk, and to dry samples.



Warning: Let the centrifugal fan and rotor come to a complete stop without using your hand or any other object as a brake to stop the rotor assembly more quickly. Some rotor configurations contain plastic and are relatively fragile and can be damaged if they contact a solid object sharply. Replacement of carrier components is not covered under the warranty.

3.2 Set-Up the Cold Trap

3.2.1 Low-Boiling Solvents

- a) Fill cold trap with approximately 1L of the desired solvent into the top of the dry ice trap until the level is about 15cm deep. In most cases, denatured ethanol is an appropriate solvent.



Note: The solvent that should be used in the cold trap is dependent on the solvent that is being removed from the solvent. If the temperature of the cold trap is too low, it is possible that the evaporated solvent may freeze in the trap or tubing and cause a blockage, thereby restricting the flow of recirculating gas in the system.

- b) Gently drop several dry ice pellets into the trap to begin the chilling process of the cold finger at the center of the trap. Add enough dry ice to maintain the cold temperature of the trap for the period of time required for the drying operation. Replace the cover of the trap to minimize the loss of the solvent through evaporation.

Typical drying rates of some common solvents are presented in Table 3-1.

Table 3-1: Drying Rates for Typical Solvents

Solvent	Rotor*	Total Volume in Rotor	Temp. °C	Time to Dry Rotor
Methanol	A	6 X 10mL	40	60 min
Water	A	6 X 5mL	40	3 hrs
Hexane	A	6 X 10mL	40	15 min
Acetone	A	6 X 10mL	40	35 min
Isopropyl Alcohol	A	6 X 10mL	40	70 min
DMSO	A	6 X 1mL	40	12 hrs
Methylene Chloride	A	6 X 10mL	40	25 min
AcN/H ₂ O (70/30)	A	6 X 10mL	40	3 hrs
Methanol	B	8 X 1mL	40	65 min
Hexane	B	8 X 1mL	40	15 min
Acetone	B	8 X 1mL	40	20 min
Isopropyl Alcohol	B	8 X 1mL	40	50 min
DMF	B	8 X 1mL	40	4 hrs
Ethyl Acetate	B	8 X 1mL	40	25 min
Methylene Chloride	B	8 X 1mL	40	18 min
Acetonitrile	B	8 X 1mL	40	35 min
AcN/H ₂ O (70/30)	B	8 X 1mL	40	3 hrs
*Rotor Key				
A	6 x 20mL Scintillation Vial			
B	8 x 1.6mL Eppendorf Tube			
C	8 x 16mm x 100mm Test Tube			

3.2.2 Frozen Water Bottle Convenience with Higher-Boiling Solvents

- a) If the solvent to be condensed has a higher boiling point such as Water, IPA, DMF, or DMSO, frozen water is probably sufficiently cold to condense the vapor from the recirculating gas and give a good evaporation rate. Freezing an appropriately sized water bottle is a convenient, no-mess way of condensing most solvents in the trap.



Note: The amount of vapor removed from the recirculating gas as it passes through the trap and around the internal cold finger is dependent upon the temperature of the trap surfaces and the residence time of the vapor. The drier the gas which is returned to the Centrifan, the more vapor it will be able to carry to the trap as it continues to circulate.

- b) Gently lower a frozen water bottle into the top of the cold trap and then pour a small amount of water into the space between the trap and the bottle to maximize thermal conduction.



3.3 Loading Samples in the Centrifan PE

A view of the splitter separated from the rotor in the Centrifan PE is presented in Figure 3-1.

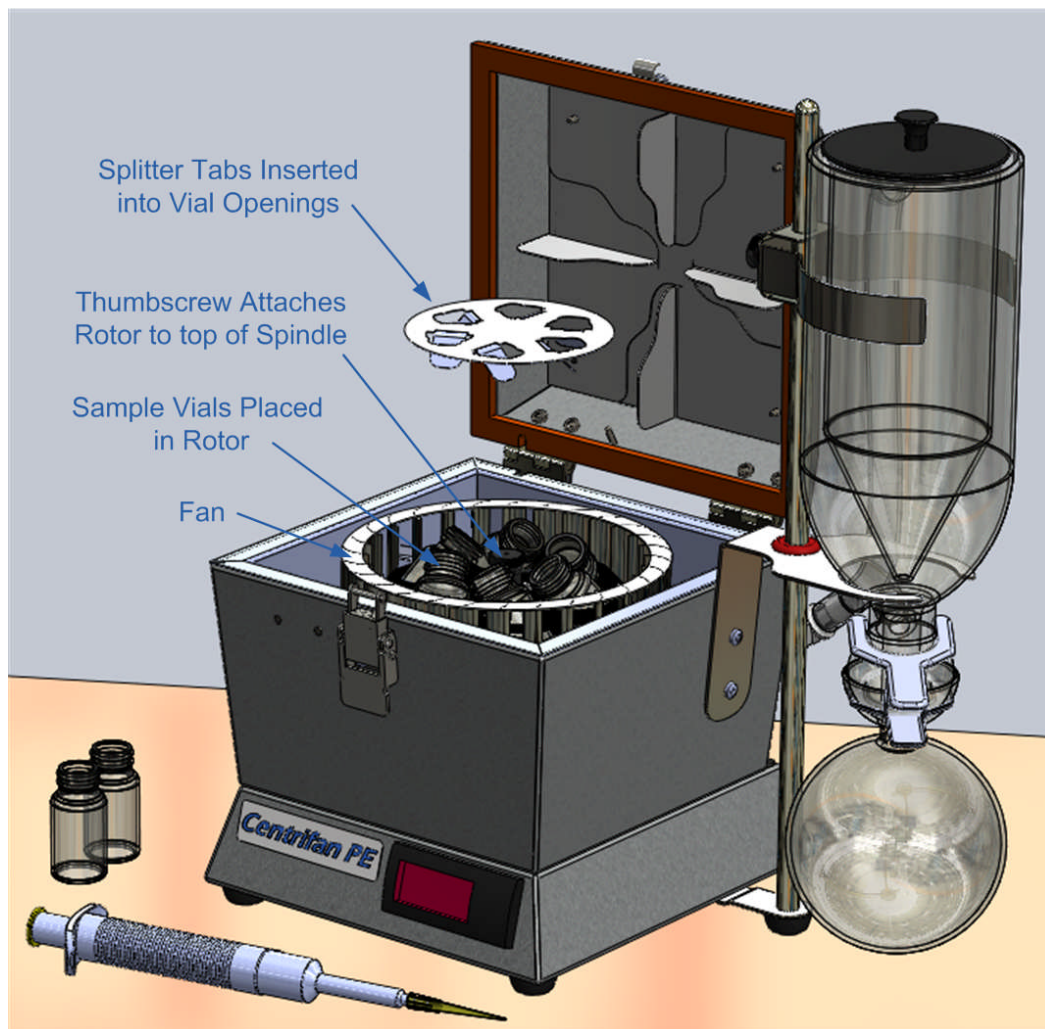

Figure 3-1: Internal Components of the Centrifan PE

To load samples in the Centrifan PE

- a) Open the lid and remove the splitter from the openings of the vials sitting in the pockets of the rotor.
- b) If used vials are present in the rotor, remove them and replace with new vials containing samples that are to be dried.



Note: Several different rotors are available for the system. If the rotor is to be replaced because of different size containers, remove the present rotor by unscrewing the fastener at the top of the rotor and lifting the rotor straight up out of the fan. Lower the new rotor in position and turn the rotor within the fan until it drops and locks itself relative to the fan. When the rotor and fan can only turn together, reinstall the screw without overtightening.



Warning: Make sure to rotate the rotor within the fan until the rotor drops the last half inch onto the top of the driveshaft. The flat at the top of the driveshaft must align properly with matching flat or dowel pin inside the hole in the bottom of the rotor. If the rotor is not properly seated on the driveshaft the rotor components will not be sitting low enough inside the fan assembly and they could strike the heat sink fins on the underside of the lid when it is closed. This could cause significant damage to the rotor and splitter.

- c) Insert the vials into the positions in the rotor located inside the centrifugal fan. The rotor should be balanced within a three or four milliliters, by locating vials containing similar amounts of liquid on opposite sides of the rotor. If there are less than the maximum number of samples to run, insert empty vials into the unused locations in order to make sure the splitter fits properly on top of the rotor and to preserve drying gas flow patterns.



Caution: For safe operation, the system should be balanced. Ensure that there is a vial with the equivalent amount of material at a position 180° from each vial placed in the rotor. In addition, it is recommended that all unused positions on the rotor are filled with empty vials.

- d) Set the tabs of the gas splitter roughly on top of the vial openings and gently twist each tab into its corresponding vial opening until the splitter is positioned concentric with the circular features of the fan and rotor.
- e) Ensure that the power switch at the rear panel AC line cord connector is set to on.
- f) If an inert gas is used to displace oxygen from the unit during the drying operation, make certain that the gas is turned on and that the vent tube is located in a hood. Dipping the end of the vent tube in a beaker of water will show the slow trickle of gas flowing from the enclosure and confirm that excess inert gas is not being consumed unnecessarily. The spinning fan generates the blow-down gas flow, not the gas introduced into the unit through this oxygen displacement tubing.
- g) Close and latch the lid to start the fan and rotor assembly and the drying process. Check the temperature controller to be sure the desired temperature has been entered (see Section 3.4 for operation of the temperature controller). Set the desired temperature using the buttons on the temperature display. The temperature can be set to a maximum of 55°C. If the controller is set to a temperature below ambient, the enclosure will drop several degrees below ambient due to evaporative cooling effects and the decreased temperature of the dried gas returning from the cold trap.

- h) On a periodic basis, empty the round bottom flask. The waste solvent should be disposed of in a manner that is consistent with local environmental regulations. In some applications, the round bottom flask may contain the desired product. In others, the condensate may be extraction solvent suitable for recycling.



Note: If you are evaporating different solvents in consecutive runs, rinse out the flask to ensure that the previous solvent is not present if there is the possibility of chemical interactions between the solvents.



Note: The Centrifan is designed so that the solvent is retained in the vials and vapor is rapidly swept from the system. The components inside the Centrifan are constructed from polypropylene, stainless steel, and other materials with solvent resistant coatings so that the possibility of corrosion due to the evaporated solvent is minimized. In the unlikely event of liquid spilling into the stainless liner, mop up the liquid as soon as possible and rinse with water or a miscible solvent such as isopropanol.

3.4 Setting the Temperature

When the system is powered up, the temperature controller will indicate the ambient temperature. To change the temperature:

- Press the **SET** button 2 (two) times to display the present set point.
- Use the ▲ or ▼ buttons to display the desired setpoint temperature.
- Press the **SET** button again to accept the indicated temperature as the set point.



Note: If you do not press the SET button within one minute, the display will revert to the ambient temperature and the edited setpoint change will be lost.

3.5 Setting the Timer

The Centrifan PE-T version of the Centrifan product includes a timer module designed to shut off the unit and stop the evaporation process at a pre-determined time. It also has a manual mode which allows the timer module to function like an on-off switch for the unit.

3.5.1 Operating in Manual Mode

In the manual mode, the display will show the status of the switched output of the timer as either ON or OFF.

- Press the SET button to toggle the output between the ON and OFF states.

3.5.2 Operating in Timer Mode

If the display is showing OFF and pressing the SET button causes the number 0 to appear, then the module is in the timer mode. To confirm that the module is in the timer mode, no lighted dot will be visible at the lower left corner of the display.

- Use the ▲ or ▼ buttons to set the desired amount of time (in minutes) that the Centrifan is to evaporate the samples.
- When the display shows the desired run time for the samples, press the SET button again to turn the module ON (the display will momentarily show RUN and then display the time remaining until the module shuts off the Centrifan). While the timer is counting down the minutes, a lighted dot will blink in the top left corner of the display.

- c) To interrupt the evaporation the timer module can be deactivated by holding down the SET button for 1 second. The unit will beep and display End and OFF showing that the time interval has been deleted.



Note: To immediately shut off and stop the Centrifan, just open the lid.

3.5.3 Switching between Manual and Timer Modes

The user can switch between the two timer module modes, manual and timer, by following the steps below:

- a) Press and hold the SET button for about 8 seconds at which time the display will show the characters Ut.
- b) Use the ▲ or ▼ buttons to cycle through the four parameters, “Ut”, “toP”, “bc”, and “MAn”. Press the buttons until “MAn” is displayed.
- c) Press SET to view the current value of the “MAn” parameter (ON=manual mode, OFF=timer mode).
- d) Use the ▲ or ▼ buttons to toggle between ON and OFF.
- e) Press SET to lock in the parameter.
- f) Press the SET and ▼ buttons simultaneously to quit the programming mode or wait one minute and it will quit automatically.

Chapter 4 Maintenance and Troubleshooting

4.1 Maintenance

This section describes a series of activities that should be performed on a routine basis to optimize the performance and ensure long term, safe operation of the Centrifan PE Personal Evaporator. The suggested frequency for each activity indicated below is based on the “typical operation” of the system and is dependent on a variety of factors such as the nature of the solvent and of the sample. Over time, it is likely that the user will determine an appropriate schedule that meets the specific application of system.

4.1.1 Cleaning the System

The exterior surfaces of the system should be cleaned with a cloth using water with a mild detergent on a periodic basis and whenever mobile phase or sample is accidentally spilled on the system. If a mild detergent is not able to remove the foreign material, an organic solvent such as methanol or isopropyl alcohol can be used. Do not get solvent on the temperature controller or it may be damaged.

The interior components that are exposed to solvent vapor are composed of stainless steel and other materials that can be cleaned with a mild detergent. If the solvent is not compatible with water, isopropanol or a similar solvent should be employed.

4.1.2 Removing the Stainless Liner for Cleaning

To remove the liner for cleaning:

- a) Make sure the power switch is turned off and unplug the line cord.
- b) Remove the splitter from the vial openings on the top of the rotor.
- c) Unscrew the thumbscrew from the center of the rotor and carefully lift the rotor out of the center of the fan using care not to apply excessive force.
- d) Reach down inside the fan and turn the black nut on the driveshaft counterclockwise to loosen the fan. If the driveshaft turns with the nut and slips in the fan hub, press lightly on the top rim of the fan in the front left corner while unscrewing the nut. The uneven force on the fan will keep the driveshaft from turning. Remove the nut and then lift the fan assembly straight upwards off of the driveshaft.
- e) At the rear of the unit, pull off from each fitting the connected tubing so that the fittings are free to be unscrewed.
- f) Unscrew the two right angle fittings on the back of the unit which actually pass through the space between the outer wall of the Centrifan PE and thread into the stainless liner to form a sealed volume for the recirculating gas.
- g) Lift the liner from the outer enclosure and wash or sterilize, as desired.
- h) When the liner has been cleaned, replace the liner by repeating the above procedure in the reverse order.

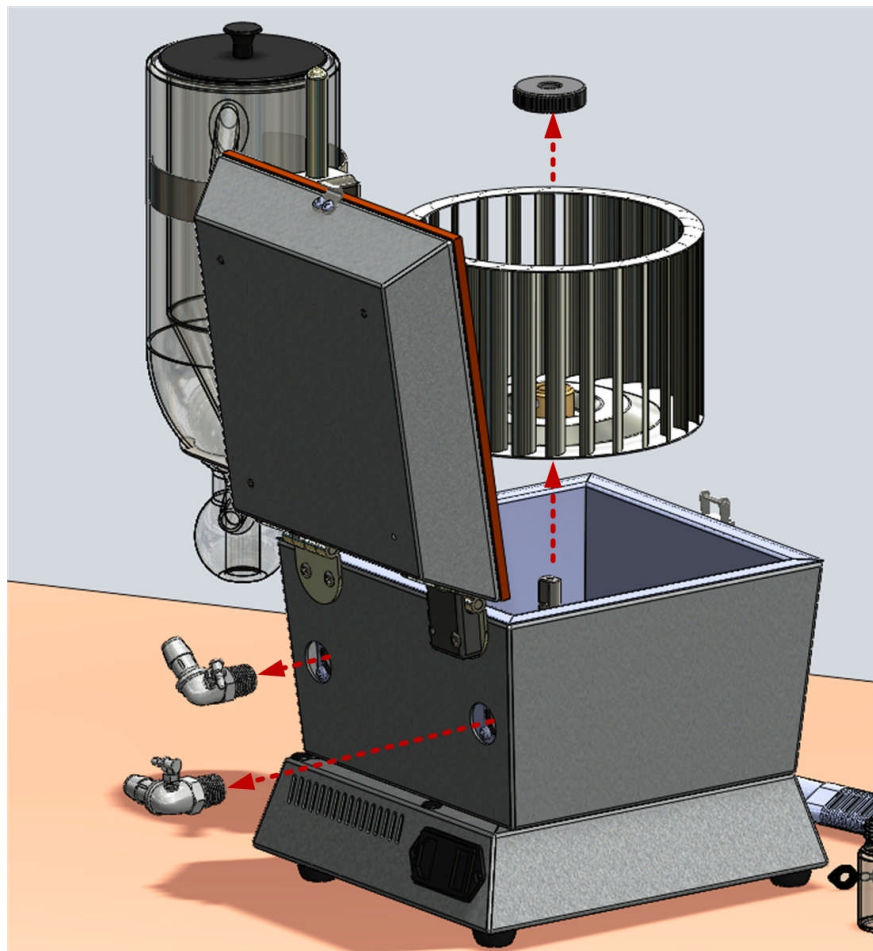

Figure 4-1: Remove Nut, Fan, and Two Fittings to Free Liner for Cleaning

4.1.3 Routine Inspection

On a periodic basis, the following activities should be performed:

- Inspect the tubing between the evaporator module and the cold trap. If the tubing is cracked, deformed or solid material is deposited inside the tubing, replace the tubing.
- Inspect the inert gas supply tubing (or the jumper tube). If the tubing is cracked, deformed or solid material is deposited inside the tubing, replace the tubing.
- Inspect the plastic carrier components for cracks or other signs of damage. Replace as required.
- Replace the solvent in the cold trap.

4.2 Troubleshooting



Note: There are no components inside the system that require any user interaction. If the system does not operate satisfactorily, please contact the manufacturer or your local agent.

Appendix A Specifications

Rotor Capacities	6 x 20mL Scintillation Vials
	6 x 30mL Scintillation Vials
	4 x 40mL Scintillation Vials
	8 x 4mL (1 Dram) Vials
	8 x 1.6mL Eppendorf Tubes
	6 x 16mm x 100mm Test Tubes
Temp Controller Range	Ambient to 55°C
Ambient Temperature	2°C to 40°C
Cold Finger Capacity	1 L non-freezing liquid plus dry ice nuggets
Power Requirements	115/230 VAC 50-60 Hz 200 watts
Fuse Ratings	3A (115V and 230V) fast acting, 5mm x 20mm
Certifications	
Dimensions	12" (30.5 cm) w x 8" (20.3 cm) d x 18" (45.7 cm) h
Weight	12 lbs (5.5 kg)

Appendix C Index

A

Accessories, 1-4, 1
Assembly, 2-3

C

Cleaning, 4-1
Cold trap assembly, 2-4
Cold trap, dry ice, 3-2
Cold trap, frozen water bottle, 3-3
Configuration, 1-4

D

Drying rates
Typical solvents, 3-2

E

Electrical Requirements, 2-2
Environmental Conditions, 2-1
Evaporation flow path, 1-3

G

Gas Flows, 1-2

I

Inert gas fittings, 2-6
Inspection, 4-2
Installation, 2-3
Introduction, 1-1

L

Loading samples, 3-4
Location of the System, 2-1

M

Maintenance, 1-4, 4-1

N

NOTE, vii

O

Operating Symbols, vii
Operation, 3-1

S

Safety Precautions, iii
Safety Symbols, vii
Shipping kit, 2-2
Space Requirements, 2-1
Spare Parts, 1
Specifications, 1
Stainless liner
Cleaning, 4-1

T

Temperature
Setting, 3-6
Temperature Range, 2-1
Timer
Setting, 3-6
Troubleshooting, 4-1

U

Unpacking, 2-2

W

Warning Symbols, vii
Warnings, iii
Warranty, v